

Trigonometry – Missing Angles

Calculate the size of the angle θ in each triangle.

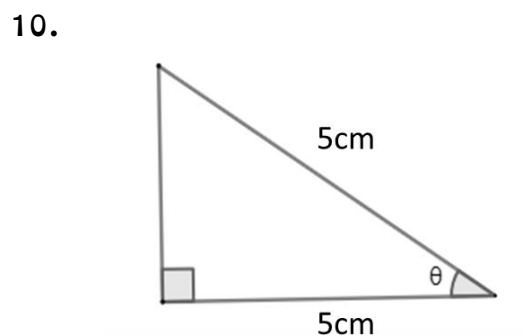
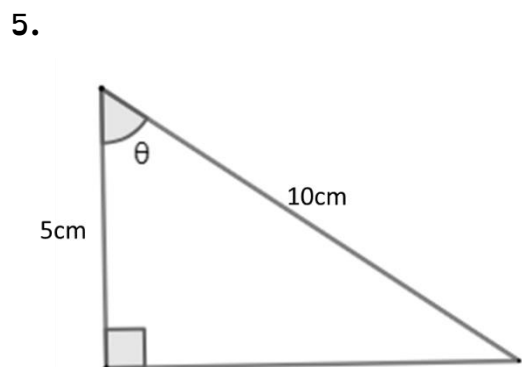
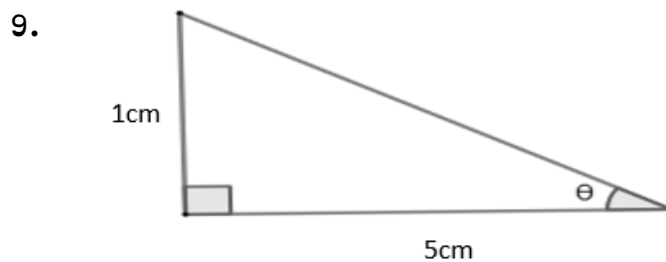
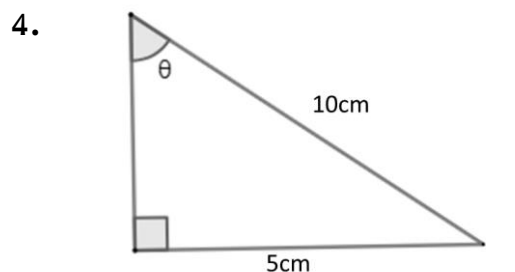
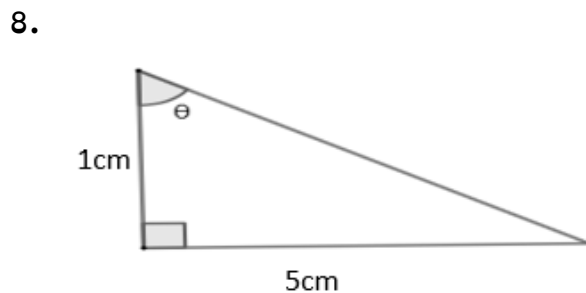
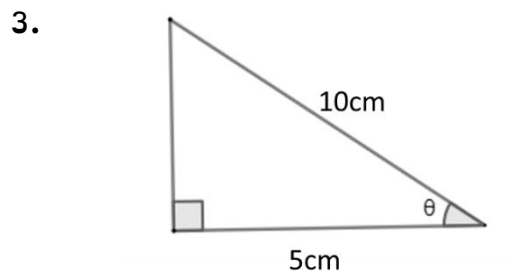
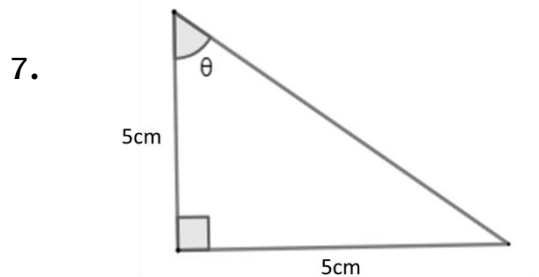
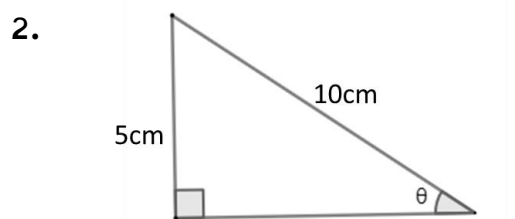
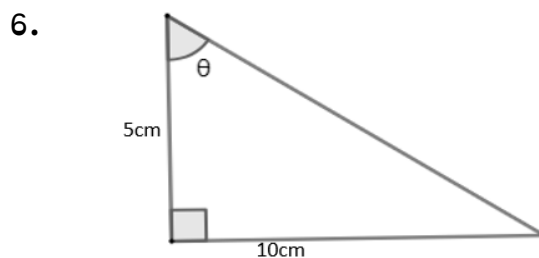
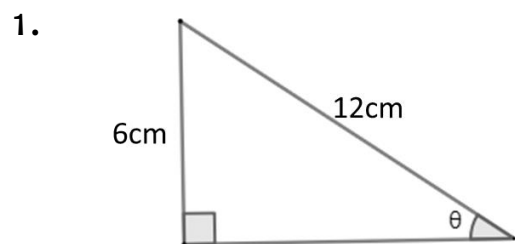

Trigonometry – Missing Angles ANSWERS

Calculate the size of the angle θ in each triangle.

